



sij | ravne systems

TURNKEY PROJECTS



FLEXIBILITY • SHORT SUPPLY • HIGH QUALITY • EXPERIENCE

Knowledge and rich experience in metallurgical, mechanical engineering, transport and manipulation systems, power supply and mining industries combined with the knowledge of materials and technologies and adequate equipment for the production enable us to manufacture high quality products and equipment.

We offered a turnkey solution, from conceptual design to customized engineering solutions and on-site installation.

**UNIQUE SOLUTIONS TAILORED TO CUSTOMERS NEEDS
FIRST CLASS ENGINEERING AND SPECIALIZED TECHNICAL EQUIPMENT**

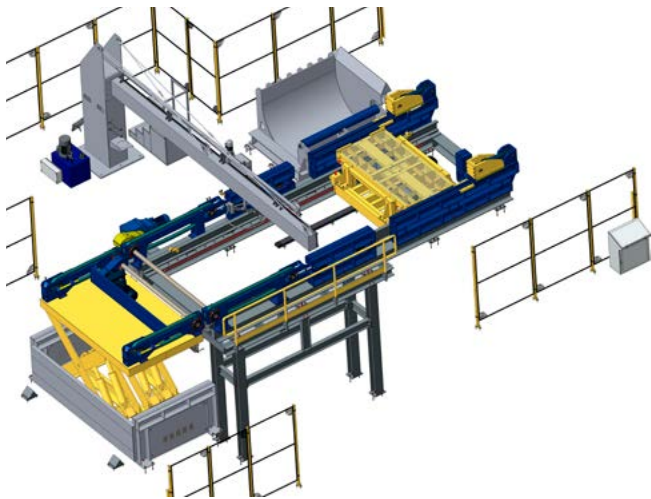

AUTOMATED TRANSPORT SYSTEMS FOR ALUMINIUM SLABS

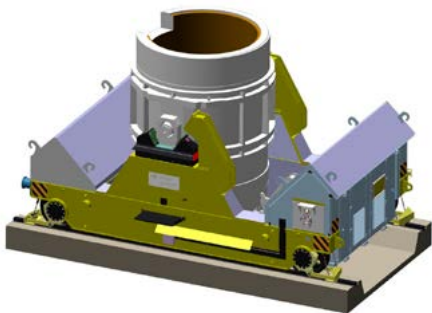

LADLE TRANSFER CAR

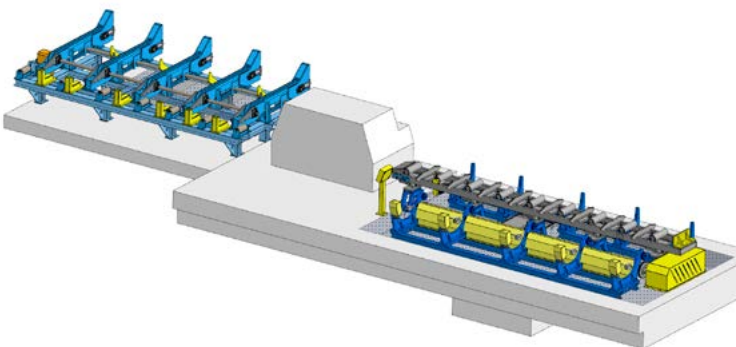

LOADING AND UNLOADING DEVICES
FOR STRAIGHTENING MACHINE



SPECIALIZATION IN THE FIELD OF ENGINEERING AND CUSTOMER DRIVEN SOLUTIONS • DESIGN UPGRADING • AUTOMATIZATION

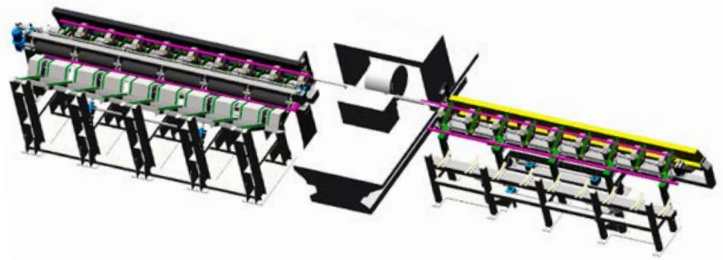

AUTOMATIC DEVICES FOR BAR PROCESSING

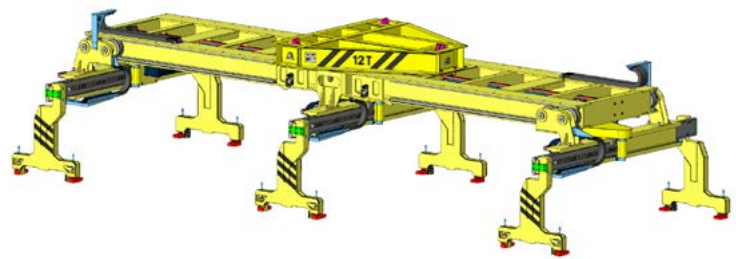
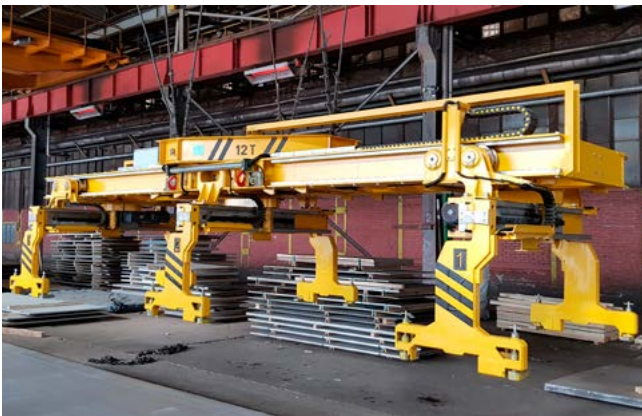

SHEET LIFTER

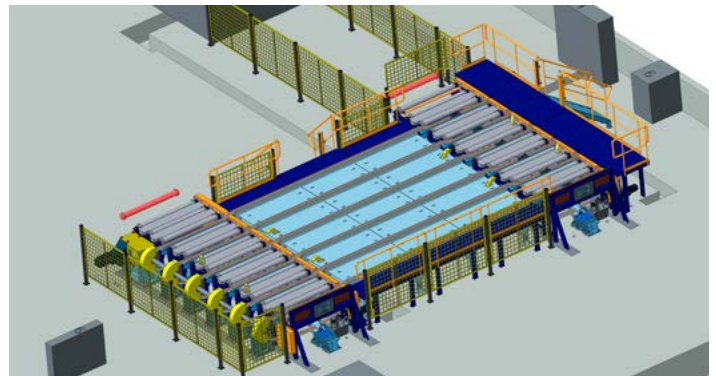

TRANSPORT SYSTEM FOR VACUUM FURNACE



VIBRATORY FURNACE CHARGER

Our engineering know-how and excellent technical support for our customers guarantees innovative technologies, which perform higher productivity, safety and autonomous of operation.

SIJ Ravne Systems d.o.o.

SI 2390 Ravne na Koroškem
Slovenia

T: + 386 2 87 06 200

F: + 386 2 87 06 230

E: info@ravesystems.com
sij.ravesystems.com